

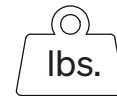

EN 13374-A



Aluminum



315

[mm]

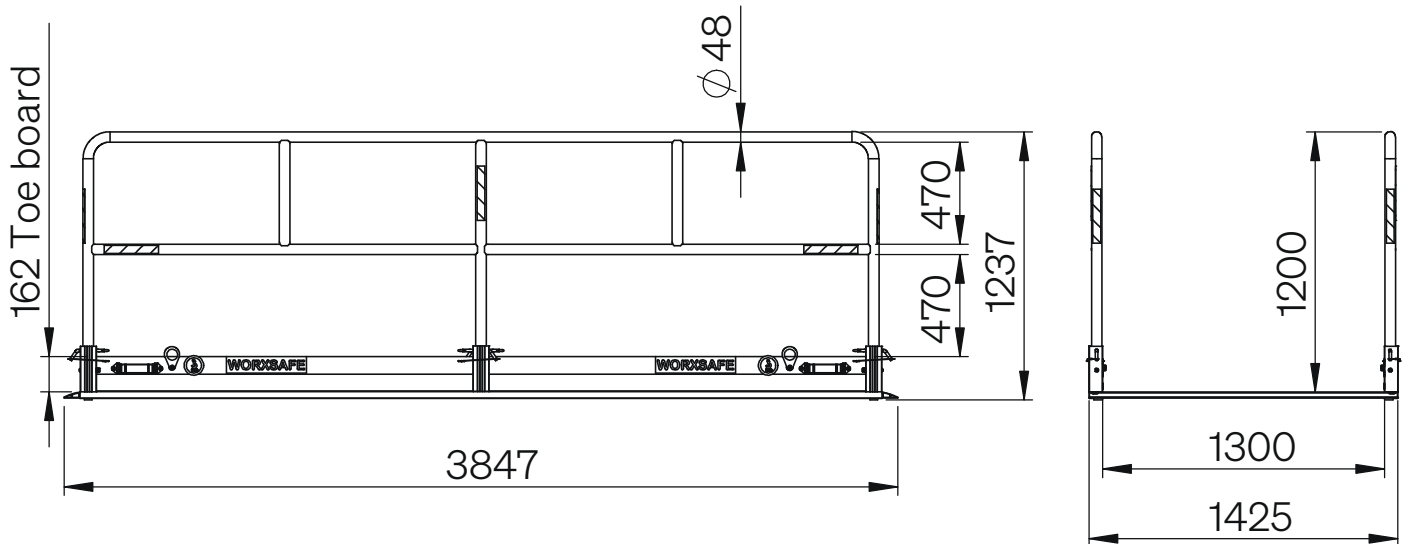

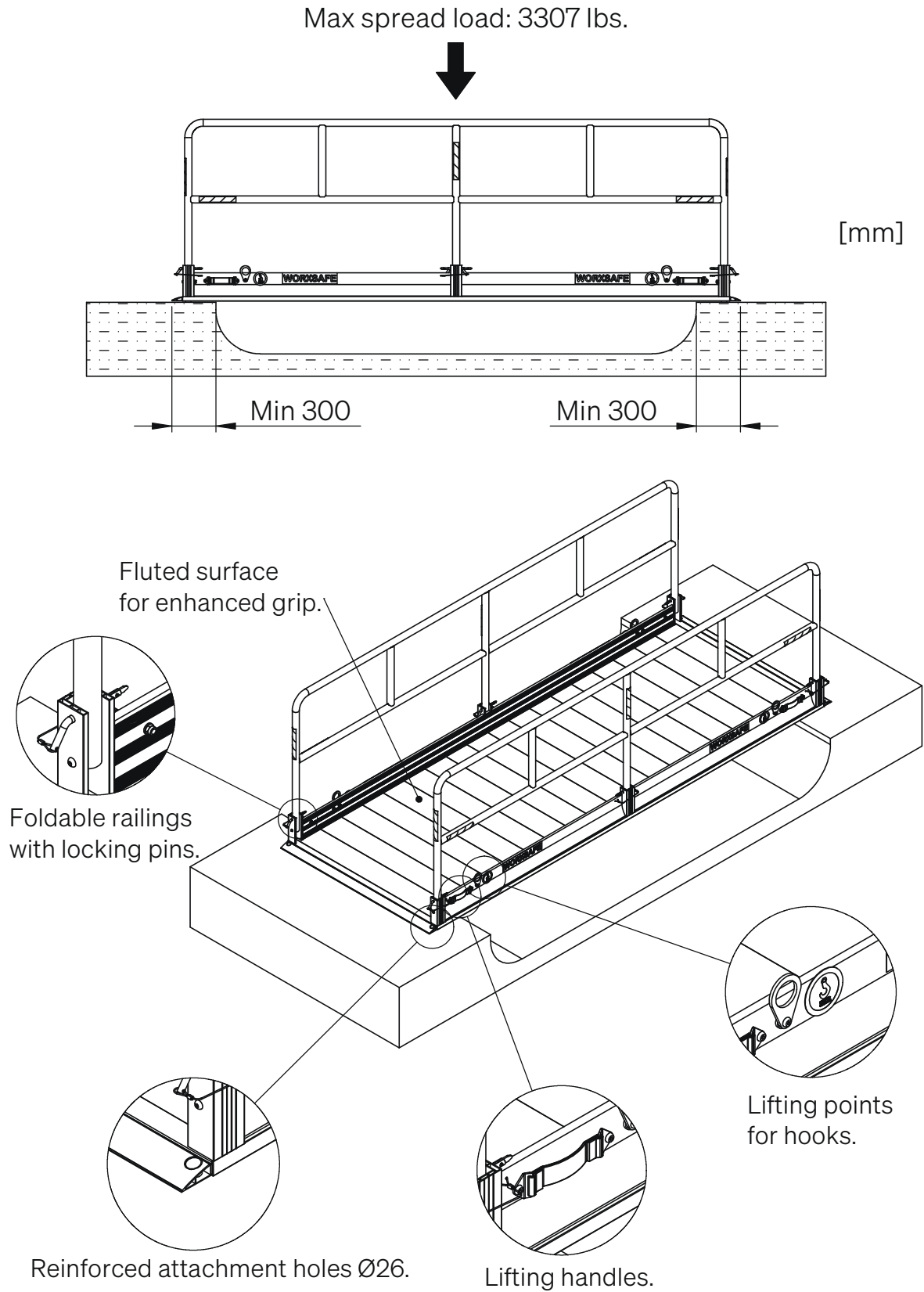
Installation

Transport/Packing

[mm]

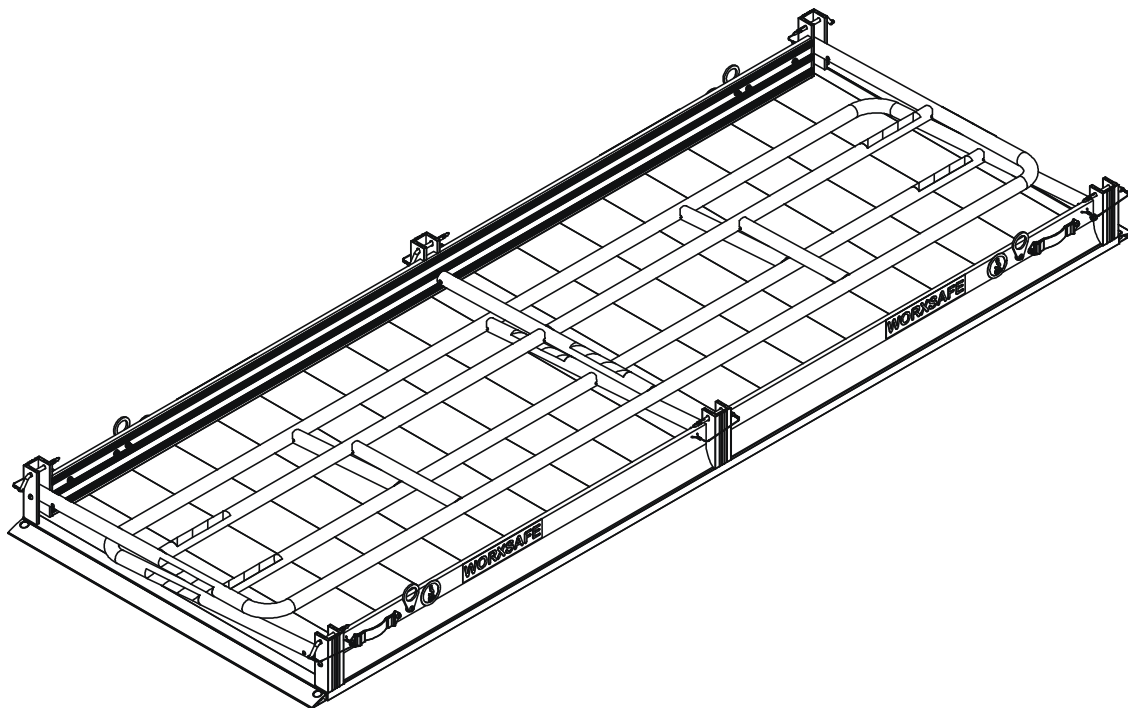
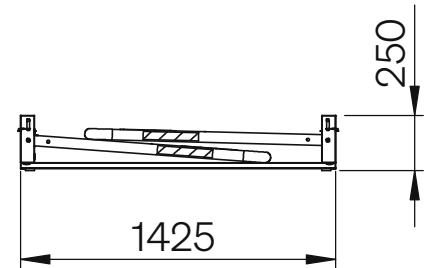
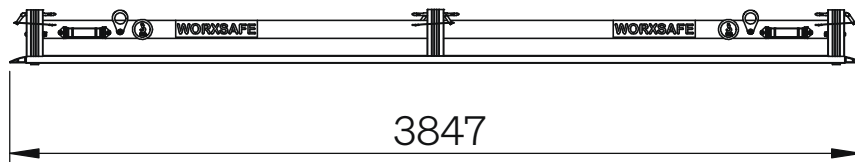

Product Family

Pedestrian Bridge - 2 m

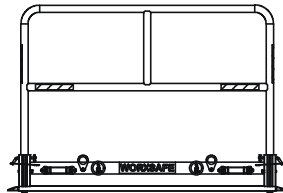

Pedestrian Bridge - 3 m

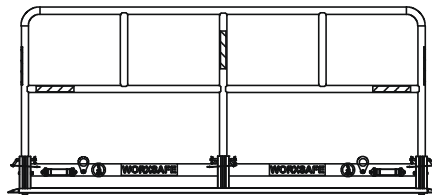

Pedestrian Bridge - 4 m

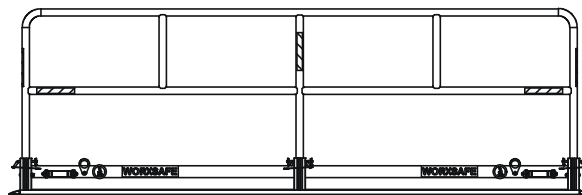

Pedestrian Bridge - 6 m

